

Half of Symbol Rate Sampling for High Density DVD Channels

In Seok Hwang, Chan Soo Hwang and Yong Hoon Lee

Dept. of EE, KAIST

e-mail: yohlee@eekaist.kaist.ac.kr

Jungwan Ko

DVD R&D Center, Samsung Electronics Co., LTD.

Abstract—Based on the fact that the effective bandwidth of regenerated RF signals of high density digital versatile disk (DVD) systems is about $1/4T$ where T is the symbol period, we propose a DVD receiver that can recover source data with rate $1/T$ after $1/2T$ sampling. This receiver employs an interpolator that increases the data rate to $1/T$. It will be shown that the proposed receiver can perform like conventional receivers with sampling rate $1/T$ at the expense of minor increase in computation. Since the proposed receiver can recover the data at twice of the A/D convertor rate, it should be very useful for high-speed data recovery.

I. INTRODUCTION

In contrast to most hard disk drive (HDD) systems whose signal bandwidth at read channel input is about $1/2T$, the bandwidth of high density DVD systems is about $1/4T$, where $1/T$ is the recovered symbol rate. For example, in Fig. 1 the measured power spectrum of read channel input (DVD RF) signals of a 4.7 G-byte DVD-ROM reaches -80 dBm at frequency $1/4T$ (6.675 MHz), and -80 dBm is about 30 dB lower than the DC value. This fact indicates that the sampling rate for DVD RF signals can be as low as $1/2T$, which is one half of the symbol rate.

The objective of this paper is to develop a DVD receiver that samples its RF signals with rate $1/2T$ and then recovers the original data having rate $1/T$. An interpolator that increases the data rate to $1/T$ will be designed, and the effects of $1/2T$ sampling/interpolation upon equalization and bit synchronization will be analyzed. It will be shown that the proposed receiver, which is based on $1/2T$ sampling, can perform like conventional receivers with sam-

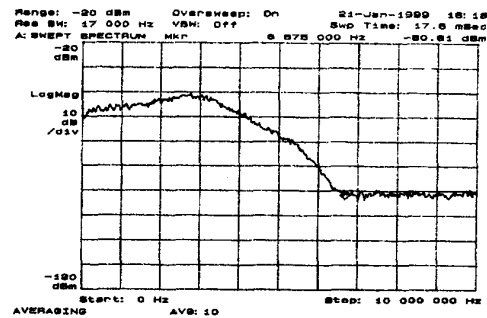

Fig. 1. The power spectrum of 4.7 G-byte DVD-ROM RF signals, where $1/T$ is 26.7 MHz.

pling rate $1/T$ at the expense of minor increase in computation. Since the proposed receiver can recover the data at twice of the A/D convertor rate, it should be very useful for high-speed data recovery.

II. THE PROPOSED RECEIVER STRUCTURE

In this section, we shall introduce the receiver structure employing $1/2T$ sampling, after briefly reviewing DVD systems.

Fig. 2(a) and (b) illustrate the block diagrams of a DVD system and the channel model, respectively. The sequence $\{a_k\}$ is generated through runlength-limited (RLL) encoding and non-return-to-zero-inverted (NRZI) modulation of user data. DVD systems employ the eight-to-fourteen modulation plus (EFM+) code which is a special case of RLL(2,10) codes [1]. The channel is modeled by a modulation transfer function (MTF) corrupted by additive white gaussian noise (AWGN) and cross-talk between neighboring tracks [2]. At the receiver, the chan-

nel output signal $z(t)$ is passed through a lowpass filter (LPF) of bandwidth $1/2T$ and sampled with rate $1/T$. The symbol synchronizer block recovers the read channel clock from sampled data stream. The stored data $\{a_k\}$ are estimated from sampled data $\{z_k\}$ by using a detection scheme such as the partial response maximum likelihood (PRML) method [3], [4].

The proposed receiver structure is illustrated in Fig. 2(c). Since the bandwidth of the channel output $z(t)$ is about $1/4T$, $z(t)$ is filtered by a LPF with bandwidth $1/4T$ and sampled with rate $1/2T$. The sampled data are then interpolated by a factor of two. The interpolator consists of the sampling rate expander, inserting a zero-valued sample between each pair of input samples, and the interpolation filter which is a digital LPF with normalized bandwidth 0.25. The output of the interpolator, denoted by \hat{z}_k , is an estimate of z_k in Fig. 2(b). Since the data rate of z_k and \hat{z}_k are identical, the symbol detector and bit synchronizer in the proposed structure can be the same as those in Fig. 2(b). However, use of \hat{z}_k instead of z_k for symbol detection may degrade the detection performance, and the latency of the interpolation filter may affect the symbol synchronization. Some details in designing each block of the proposed receiver are described in the following section.

III. DESIGN CONSIDERATIONS

We examine the design parameters of the analog LPF, digital interpolator and symbol synchronizer through computer simulation. The block diagram of the simulator is shown in Fig. 3. To simulate analog devices, this simulator operates at rate $8/T$. The source sequence $\{a_k\}$ is inputted to the sampling rate expander, which inserts seven zero-valued samples between each pair of input samples. The impulse response of the MTF was obtained via the inverse discrete Fourier transform of the trigonometric model [2]. The duration of the MTF was set at 31 symbol period. The MTF output is corrupted by both additive white gaussian noise (AWGN) and inter-track crosstalk

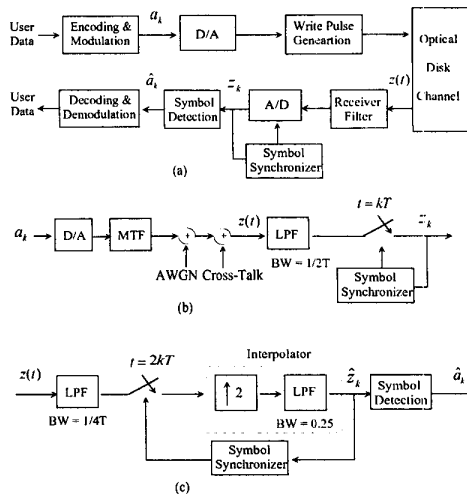

Fig. 2. A DVD system: (a) an overall system, (b) the channel model with sampling rate $1/T$, and (c) the proposed receiver structure.

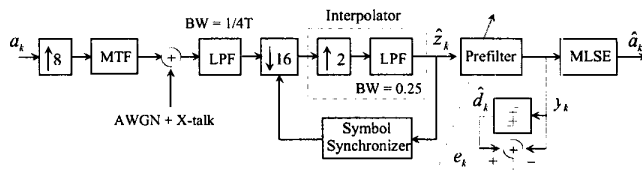

Fig. 3. Block diagram of channel simulator

which is about -35 dB in 4.7 G-byte DVD-ROM system. Samples with rate $1/2T$ are obtained by decimating the lowpass filtered signal by a factor of 16. After interpolation, the sequence $\{\hat{z}_k\}$ is transferred into the PRML detector consisting of an adaptive prefilter and MLSE. The prefilter adaptively shapes the channel impulse response (CIR) into a desired target response, say $P(z)$. We set $P(z) = (1 + z^{-1})(1 + z^{-1} + z^{-2})$; this is obtained by using the MMSE approach in [5]. For prefiltering, an adaptive transversal filter with span 15 is employed; its tap coefficients are obtained via the least mean square (LMS) algorithm. Of course, the MLSE is implemented by means of the Viterbi algorithm. As a performance measure, we consider the detection SNR which is the ratio between the power of the desired signal d_k and that of the error signal e_k at the prefilter output [3]. Here the desired signal $\{d_k\}$ is obtained by passing the source sequence $\{a_k\}$ through

the target system $P(z)$. Throughout our simulation, the detection SNR of a conventional system with sampling rate $1/T$ is compared with those of the proposed system.

A. Design of Analog LPF and Interpolator

Since the channel bandwidth of high density DVD systems is about $1/4T$, conventional DVD receivers with sampling rate $1/T$ do not require an efficient analog LPF having narrow transition band. For such receivers Bessel filters with bandwidth $1/2T$, whose magnitude response is shown in Fig. 4, are often employed because of their excellent phase response characteristic. On the other hand, the proposed receiver would need an analog LPF with a sharper magnitude response. This is because the Bessel filter with bandwidth $1/4T$ exhibits considerable passband droop, as shown in Fig. 4, and tends to smear the input signal in the passband region. One may employ either the Elliptic or the Butterworth filters, also illustrated in Fig. 4, and try to compensate the phase distortion caused by such filtering through the prefiltering in the PRML detector.

The digital interpolation filter can be designed by using well known techniques such as the Parks-McClellan algorithm and the least squares (LS) method [6]. Fig. 5 illustrates magnitude responses of some candidate interpolation filters designed via the LS method. All these filters are finite impulse response (FIR) filters with passband $[0, 0.22]$ and stopband $[0.28, 0.5]$. To reduce the passband distortion the weight for passband is set to 50, while setting the weight for stopband at 1. One of these filters may be chosen after considering the tradeoff between the implementational complexity and the receiver performance.

To examine the influence of the analog LPF on the receiver performance, analog LPFs in Fig. 4 are applied to the simulator in Fig. 3 and the resulting detection SNR values are empirically estimated. In the simulation, the analog LPFs are converted into digital LPFs via the impulse-invariant transform and the interpolation fil-

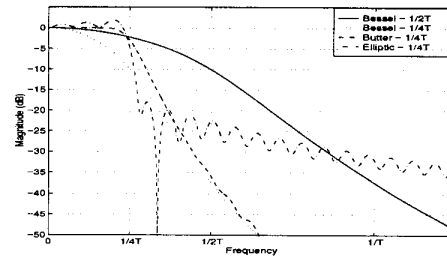

Fig. 4. Magnitude responses of analog LPFs (6th order).

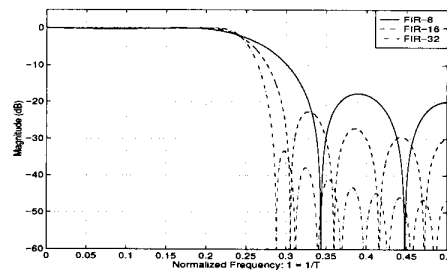

Fig. 5. Magnitude responses of some candidate interpolation filters.

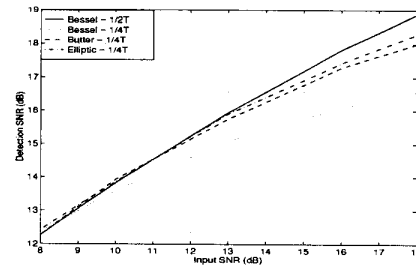

Fig. 6. Detection SNR values for the analog LPFs in Fig. 4.

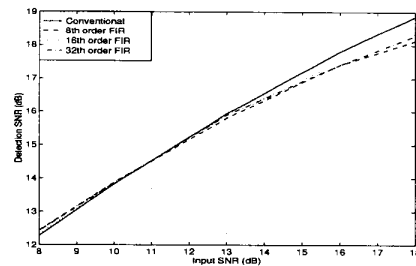

Fig. 7. Detection SNR values for the interpolation filters in Fig. 5.

ter with order 32 in Fig. 5 is employed. The detection SNR values, shown in Fig. 6, indicate that the Bessel filter with $1/4T$ bandwidth considerably degrades the receiver performance. On the other hand, the Elliptic and Butterworth filters of bandwidth $1/4T$ causes only minor performance degradation. Therefore, either one of them may be employed in the proposed receiver.

The influence of the interpolation filter is examined by applying the FIR filters in Fig. 5 to the simulator in Fig. 3. In this case the Elliptic filter of bandwidth $1/4T$ is employed as the analog LPF. The resulting detection SNR values are shown in Fig. 7. It is seen that all the FIR interpolators behave in a similar manner. Therefore, use of the FIR filter of order 8 for interpolation is recommended.

B. Symbol Synchronizer

Symbol synchronization is achieved by estimating the frequency and phase of regenerated RF signals. The frequency can be estimated by using a phase locked loop (PLL) which detects frequency offset by help of a sync pattern such as the SYNC codes in the 2.6 G-byte DVD-RAM [8]. After locking the frequency, the phase is estimated. In this case, the phase error can be detected by using some simple techniques such as the zero-crossing timing error detector (ZC-TED) [7]. Next we shall analyse the influence of the interpolator on the phase detector.

In the proposed receiver, it is natural to estimate the timing phase error from the interpolator output. Therefore, as shown in Fig. 8(a), the PLL for phase estimation consists of the interpolator, a phase detector, a loop filter and a voltage controlled oscillator (VCO). The model of this PLL is shown in Fig. 8(b). The term z^{-d} represents the delay caused by interpolation; $L(z)$ and $\frac{1}{1-z^{-1}}$ represent the loop filter and VCO, respectively. Since the interpolation filter is a linear phase FIR filter, the delay d is equal to one half of the filter order. Therefore to keep an integer valued d even order interpolation filter should

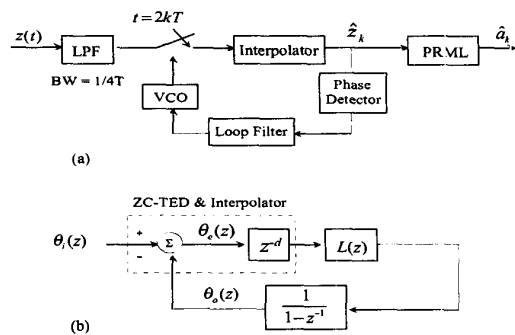

Fig. 8. A timing recovery scheme: (a) an overall structure, and (b) a linearized PLL model with loop delay.

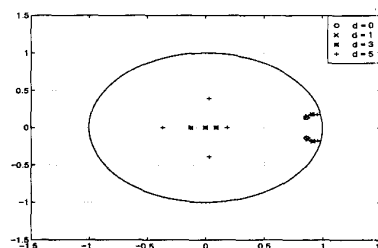

Fig. 9. Pole locations of $H(z)$ with loop delay d ; where $\alpha = 0.8$, $\beta = 0.2$, and $K = 0.05$.

be employed. If we set

$$L(z) = K \frac{(1 - \beta z^{-1})}{(1 - \alpha z^{-1})} \quad (1)$$

then the system function $H(z)$ of the PLL is given by

$$H(z) = \frac{K z^{-d} (1 - \beta z^{-1})}{1 - (1 + \alpha)z^{-1} + \alpha z^{-2} + K z^{-d} - K \beta z^{-(d+1)}} \quad (2)$$

Fig. 9 shows the pole locations of $H(z)$. As d increases the poles tends to approach the unit circle. Therefore to ensure the stability, special care in the loop filter design is required when a higher order interpolation filter is employed.

To examine the behavior of the PLL in Fig. 8, it is applied to the timing recovery of the 4.7 G-byte DVD-ROM. In this system, the timing phase is estimated by help of a sync pattern called the VFO pattern consisting of 576 channel bits. At the end of this pattern period the timing jitter variance should be less than 2.5×10^{-3} which corresponds to 5 % timing error. In our simulation, ZC-TED is

employed as the phase detector; the 6-th order Elliptic in Fig. 4 and 8-th order interpolation filter are used; the loop filter parameters are: $\alpha = 0.8, \beta = 0.2$, and $K = 0.05$. The initial phase offset is $-0.5T$. Tabel I summarizes the mean acquisition time, which is the time to reach 5% timing error, and the steady state jitter variance. For comparison, simulation results for the conventional receiver are also listed. It is seen that both the proposed and the conventional receiver reach the steady state within the VFO pattern period and satisfy the desired steady state jitter variance. The mean acquisition time of the proposed system is somewhat longer than that of the conventional system because of the interpolation delay.

TABLE I
ACQUISITION TIME AND JITTER VARIANCE

SNR	Conventional		Proposed	
	Mean Time	Jitter Variance	Mean Time	Jitter Variance
10 dB	145T	1.88×10^{-3}	220T	1.05×10^{-3}
13 dB	100T	6.59×10^{-4}	194T	5.79×10^{-4}
15 dB	88T	3.93×10^{-4}	184T	4.35×10^{-4}
18 dB	74T	1.74×10^{-4}	186T	2.34×10^{-4}

IV. BIT ERROR RATE SIMULATIONS

In this section, we compare the bit error rate (BER) performances of the proposed and the conventional receivers. To evaluate the effects of timing jitter on BER performance, timing jitter is intentionally introduced in the simulation. (Again, the 6-th order Elliptic LPF and the 8-th order interpolation are employed.) Fig. 10, illustrates the BER values. When there is no timing error, the performance of the proposed receiver is comparable to that of the conventional one. However, the proposed receiver performance degrades as timing error increases. This degradation is caused by $1/2T$ sampling and interpolation. On the other hand, the conventional system is quite robust to timing error. Therefore, the proposed system requires more accurate symbol synchronization than the conventional system.

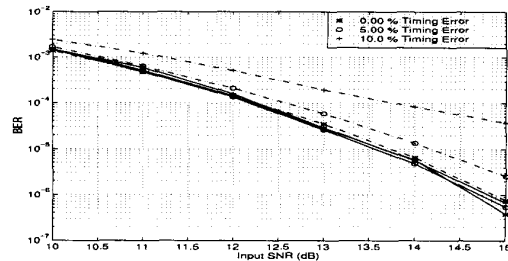

Fig. 10. BER values under various timing jitter; conventional (solid line) and the proposed (dashed dot)

V. CONCLUSION

The proposed receiver with $1/2T$ sampling can recover the data at twice of the A/D convertor rate at the expense of some increase in implementation cost. Specifically, it requires an analog LPF with a sharper transition characteristic, an interpolator and more accurate symbol synchronization. Through computer simulation for 4.7 G-byte DVD-ROM, we showed that the BER performance of the proposed can become reasonably close to that of the conventional system with sampling $1/T$ by employing the 6-th order Elliptic LPF, the 8-th order FIR interpolation filter and symbol synchronization with 5 % error.

REFERENCES

- [1] K. A. S. Immink, "The digital versatile disc (DVD): System requirements and channel coding," *SMPTE Journal*, pp. 483-489, Aug. 1996.
- [2] A. B. Marchant, *Optical Recording - A Technical Overview*, Addison-Wesley, April 1990.
- [3] J. Cioffi, W. Abbott and H. Thapar, "Adaptive equalization in magnetic-disk storage channels," *IEEE Communication Magazine*, pp. 14-29, 1990.
- [4] R. Cideciyan, R. Hermann, F. Dolivo and W. Hirt, "A PRML system for digital magnetic recording," *IEEE Journal of Selected Area in Commun.*, pp. 38-56, Jan. 1992.
- [5] D. D. Falconer and F. R. Magee, "Adaptive channel memory truncation for maximum likelihood sequence estimation," *Bell System Technical Journal*, pp. 1541-1563, Nov. 1973.
- [6] A. Antoniou, *Digital Filters: Analysis, Design, and Applications*, McGraw-Hill, 1993.
- [7] H. Meyr, M. Moeneclaey and S. A. Fechtel, *Digital Communication Receivers*, John Wiley & Sons, 1998.
- [8] DVD Consortium, *DVD Specifications for Rewritable Disc - Physical Specifications*, April 1997.